

# Schedule 40

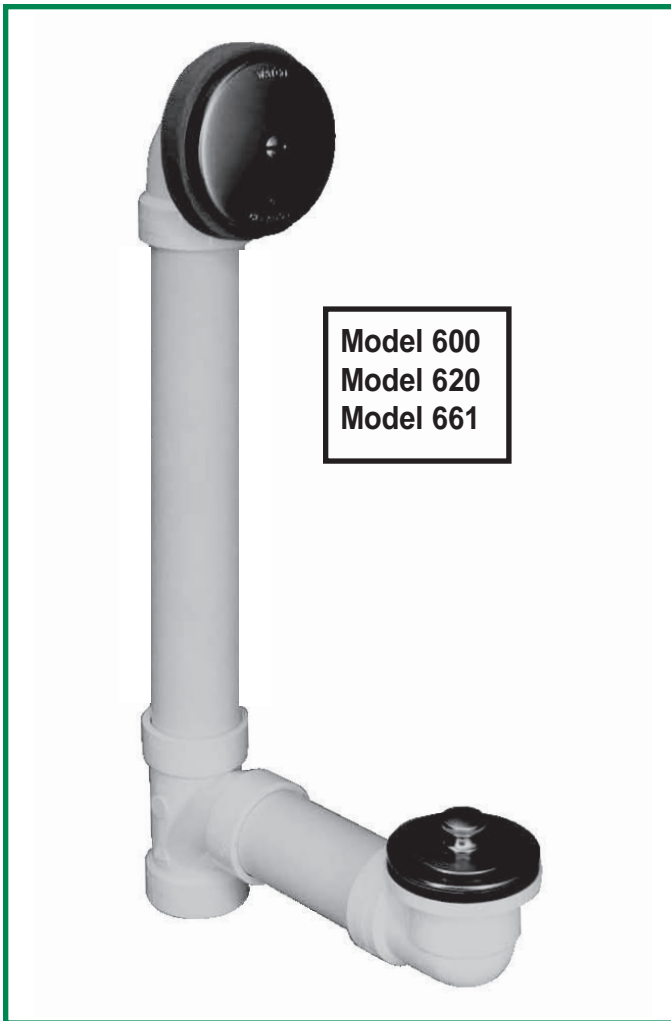

**Model 600**  
**Model 620**  
**Model 661**

## Model 600/601

Stoppers, Knobs, and Bodies determined by tub closure selected

## Model 620/621

ABS Plastic Stopper, Plastic Knob, Brass Body, Chrome PP only

## Model 661/651

ABS Plastic Stopper, Plastic Knob, Zinc Body, Chrome PP only

### Sturdy 1.5" Schedule 40 PVC or ABS Solvent-Weld Assembly

#### SPECIFICATIONS

#### FEATURES:

- 1.25" deep metal strainer body
- Theft-resistant stopper
- Designed for heavy-duty use in hotels, motels, and rental property
- Replaceable, drip-proof Buna-N-Seal

#### APPROVALS (600/601 models):

- Manufactured in compliance with ASME A112.18.2-2005/CSA B125.2-2005

#### PATENTS:

See <http://watcomfg.com/Watco/patents/> for details

#### THREADS (Strainer Body and Drain Elbow):

- 1 1/2" – 11 1/2 NPSM (Coarse Thread)
- 1.865" Major Diameter (outside thread diameter)
- 11.5 threads per inch

**PIPING:**  PVC  ABS

Not Shown: Half Kits (No Tee or Pipe)

**Model 601:** Stoppers, Knobs, Strainer Bodies determined by type of tub closure, i.e., Lift and Turn, etc.

**Model 621-PP:** ABS Stopper, Plastic Knob, Brass Strainer Body, Chrome PP only

**Model 651-PP:** ABS Stopper, Plastic Knob, Zinc Strainer Body, Chrome PP only



**ADA**

PRESFLO® (PF) and Foot Actuated (FA) only

See price list for complete item numbers and available options.

When ordering, please specify complete item number and any applicable option codes.



For More Information Contact:  
**WATCO Manufacturing Company**  
1220 South Powell Road  
Independence, MO 64057-2724  
Ph. 816-796-3900 • FAX 816-796-0875  
[www.watcomfg.com](http://www.watcomfg.com)

#### ROUGH-IN (RI's) and STOPPER/FACEPLATE (SF's)

##### STOPPER/FACEPLATE'S

(example: 600-PPSF-0-CP)

Overflow plate and stopper assembly

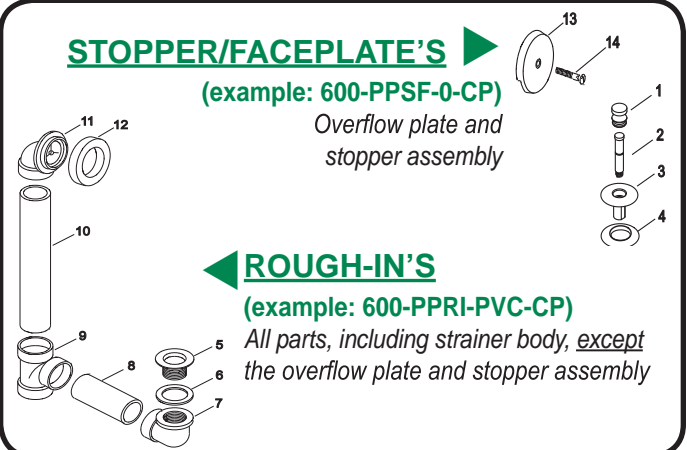

##### ROUGH-IN'S

(example: 600-PPRI-PVC-CP)

All parts, including strainer body, except the overflow plate and stopper assembly

# 600/601 Series Parts List

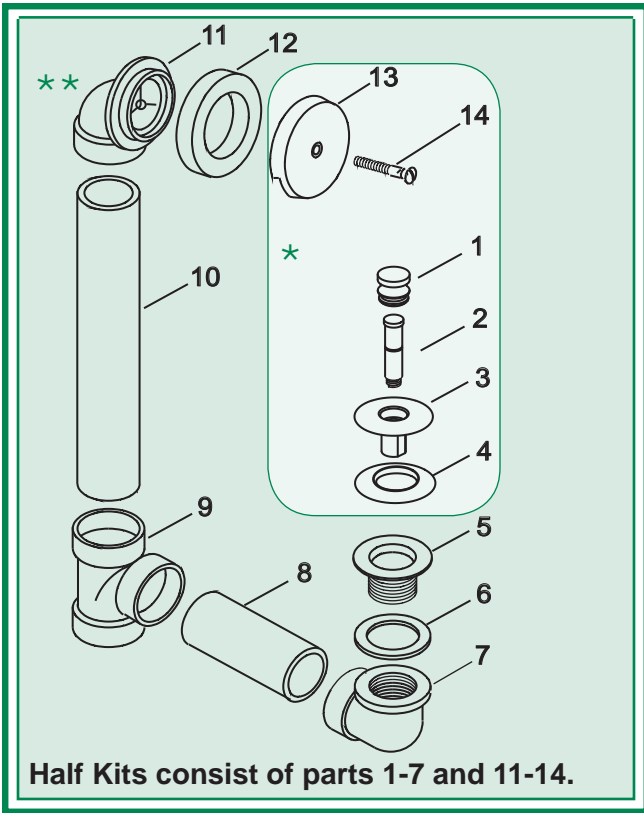

Item	Part #	Description
1.	01010CP	PUSH PULL® Knob, Brass
2.	11510	Friction Ring (11505) and Post (11532)
3.	01013CP	Stopper, Brass
4.	11507	Seal, 1 1/16" dia.
5.	01016CP	Strainer Body, 1.865" - 11.5
6.	10696	Drain Ell Washer, 1.5" gray
7.	11008	Drain Ell, Schedule 40, ABS
	14008	Drain Ell, Schedule 40, PVC
8.	SCHABS-4.625	Pipe, Schedule 40, ABS, 1.5" x 4.625"
	SCHPVC-4.625	Pipe, Schedule 40, PVC, 1.5" x 4.625"
9.	14011	Sanitary Tee, Schedule 40, ABS
	14010	Sanitary Tee, Schedule 40, PVC
10.	SCHABS-11.75	Pipe, Schedule 40 ABS, 1.5" x 11.75"
	SCHPVC-11.75	Pipe, Schedule 40 PVC, 1.5" x 11.75"
11.	11009	Overflow Ell, 1-Hole, Schedule 40, ABS
	14009	Overflow Ell, 1-Hole, Schedule 40, PVC
12.	10675	Overflow Ell Washer, Foam
13.	01002CP	Overflow Plate, 1-Hole
14.	01024CP	Overflow Plate Screw, 2.25"

\* SF: (example: 600-PPSF) Parts #1 thru #4, #13 and #14

\*\* RI: (example: 600-PPRI) Parts #5 thru #12

## OPTIONAL TUB CLOSURES FOR 600/601-SERIES BATH WASTES (PUSH PULL® ALSO SHOWN ABOVE)

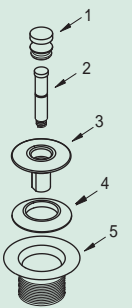
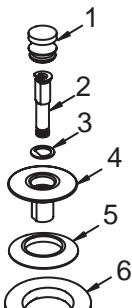
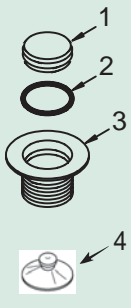
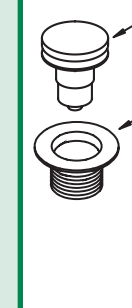
PUSH PULL® Coarse Thread	LIFT & TURN Coarse Thread	PRESFLO® Coarse Thread	FOOT ACTUATED Coarse Thread
 <ol style="list-style-type: none"> <li>01010CP</li> <li>01010__*</li> <li>11510</li> <li>01013CP</li> <li>01013__*</li> <li>11507</li> <li>01016CP</li> <li>01016__*</li> </ol>	 <ol style="list-style-type: none"> <li>01010CP</li> <li>01010__*</li> <li>11079</li> <li>11088</li> <li>11290CP</li> <li>01013__*</li> <li>11507</li> <li>11492CP</li> <li>01016__*</li> </ol>	 <ol style="list-style-type: none"> <li>11145CP</li> <li>11145__*</li> <li>11132</li> <li>11060CP</li> <li>11060__*</li> <li>96039: Suction Cup for removing stopper</li> </ol>	 <ol style="list-style-type: none"> <li>38412CP</li> <li>38412__*</li> <li>11492CP</li> <li>01016__*</li> </ol>

U.S. Pat. No. 4,720,877      U.S. Pat. No. 5,758,368      U.S. Pat. No. 4,457,030

\*If finish other than Chrome is desired, please use this part number and indicate desired finish.

## Finishes Available in the 600/601 Series:

621 PUSH PULL®
1. 11309CP
2. 11510
3. 11290CP
4. 11507
5. 01016CP

651 PUSH PULL®
1. 11309CP
2. 11510
3. 11290CP
4. 11507
5. 11492CP

Tub Closures:	PUSH PULL®	LIFT & TURN	PRESFLO®	FOOT ACT.
CP - Chrome Plated	●	●	●	●
AB - Antique Brass	●	●	●	●
AP - Aged Pewter	●	●	●	●
BB - Brushed Bronze	●	●	●	●
BN - Brushed Nickel	●	●	●	●
BO - Bone	●	●	●	●
BS - Biscuit	●	●	●	●
BZ - Oil-Rubbed Bronze	●	●	●	●
CB - Chrome Brushed	●	●	●	●
NP - Nickel Polished	●	●	●	●
PB - Polished Brass	●	●	●	●
PN - Pearl Nickel	●	●	●	●
WH - White	●	●	●	●
WI - Wrought Iron	●	●	●	●

## Roughing-In Dimensions

