

Models 6021/6521

PRO-FIT® 3672

Rectangular Whirlpool or Bathtub



Features

- 71-1/2" x 35-1/2" x 20" Rectangular whirlpool or bathtub
- Six powerful Ultra-Swirl jets
- Dual air knobs for total jet control
- Limited One-Year Warranty
- Available in standard colors: white, almond, biscuit and bone



Model 6021
(Shown with trim upgrade and Lift and Turn drain)

Options

Lift and Turn Drain

Model #	Description		Model #	Description	
PF1320	Polished Chrome		SWAP00	Nailing flange kit	
PF1321	Everbrass (PVD)		SWP150	Factory installed nailing flange	
PF1322	Brushed Nickel		PF1326A	6' Removable apron	
PF1323	Oil Rubbed Bronze				

Whirlpool Option

Metal Trim

Model #	Description		Model #	Description	
PF1335	Polished Chrome		SWP151	In-line Water Heater	
PF1336	Everbrass (PVD)				
PF1337	Brushed Nickel				
PF1338	Oil Rubbed Bronze				



MADE IN USA



Models 6021/6521

PRO-FIT® 3672

Rectangular Whirlpool or Bathtub



Specifications

Model #	Description	Codes/Standards
6021	71-1/2" x 35-1/2" x 20" Rectangular whirlpool	  
6521	71-1/2" x 35-1/2" x 20" Rectangular bathtub	

Specification	Description	Specification	Description
Material	Acrylic, fiberglass reinforced	Number of Jets	6
Construction	Self-contained, pre-plumbed whirlpool bath mounted on a pre-leveled base	Water Capacity	27 gal. (min.) / 52 gal. (max.)
Pump Motor	Single speed, 120 volt, 60 HZ, 5.8 amp, single phase, premounted	Floor Loading Weight	47 lbs. / sq. ft. (229 kg/m ²)
Electrical Requirements	120 volt, 15 AMP, GFCI protected circuits	Shipping Weight	whirlpool - 154 lbs. bathtub - 134 lbs.
On/Off Control	Air Switch	Warranty	Limited One Year

Technical Information

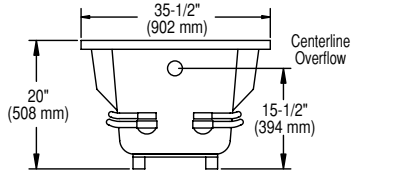
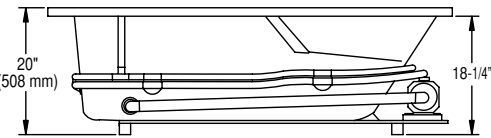
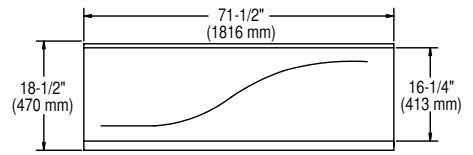
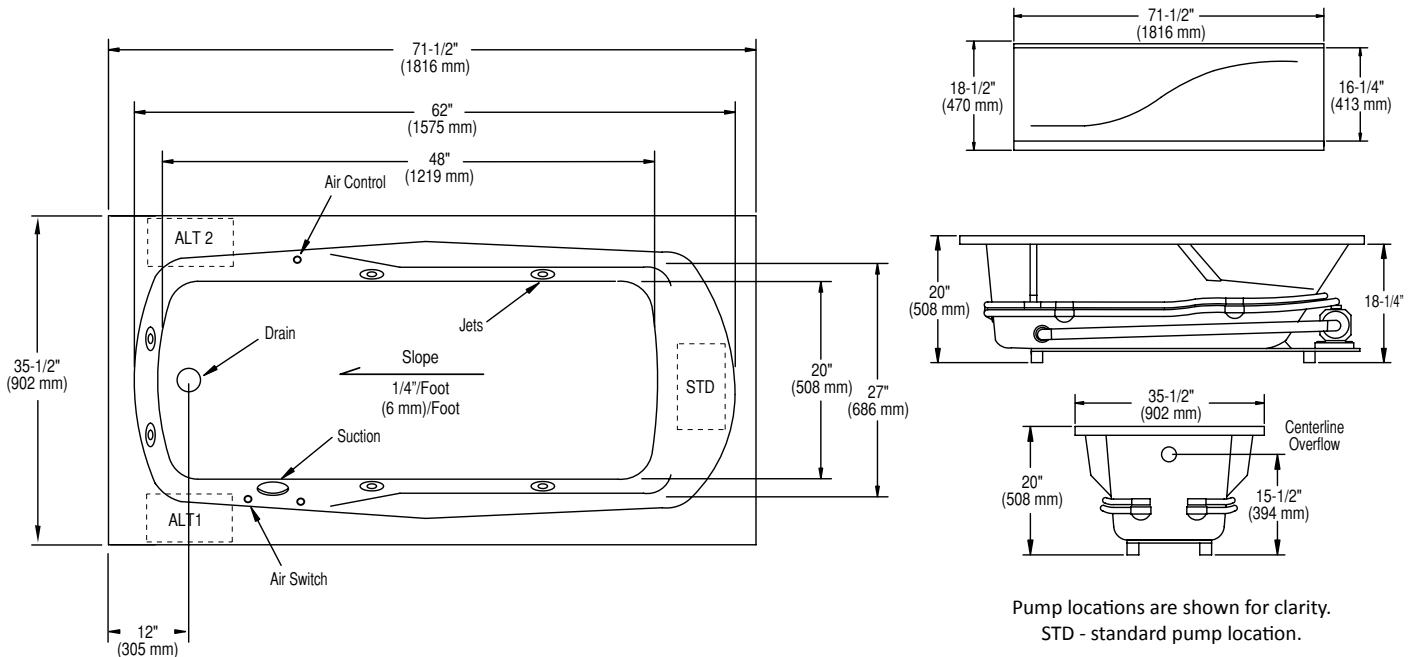

Pump locations are shown for clarity.
STD - standard pump location.

Notes: If a factory installed nailing flange is added to a unit, add 1/8" to each side flanged.

Measurements may vary 1/4" (+/-)

Install this product according to the installation guide.

These dimensions are nominal and subject to change without notice.

When tested for compliance to the requirements of ASME A112.19.7M for "Whirlpool Bath Appliances" and ANSI Z124.1.2M "American National Standard for Plastic Bathtub and Shower Units", the tested units are found to comply and are acceptable for listing under IAPMO R & T.

Certified for permanent electrical connection only.

Please visit our website to view IAPMO certification information – www.mansfieldplumbing.com



MADE IN USA