

INSTALLATION INSTRUCTION FOR 1423

WARNING! SHUT POWER OFF AT FUSE OR CIRCUIT BREAKER .
AVERTISSEMENT! COUPER LE COURANT AU NIVEAU DES FUSIBLES OU DU DISJONCTEUR.

READ AND SAVE THESE INSTRUCTIONS

ASSEMBLING THE FIXTURE (Fig.2)

1. Shut off the power at the circuit breaker and remove the old fixture, including the mounting hardware.
2. Carefully remove the fixture from the carton and check that all parts are included as shown in the illustration.
3. Thread the loop (J) onto the nipple (K).
4. Spread the arms (K1) so that the arms (K1) are at equal distance from each other.
5. Place the glass (Q) over the socket (P), and secure in place with the socket ring (R).
6. Allow the nipple (L) to pass through the hole of the panel (M) and the cap (N), then secure with the finial (O).

HANGING THE FIXTURE (Fig.1)

7. Thread the nipple (E) into loop (H) until snug.
8. Thread hex nut (D) onto nipple (E). Place lock washer (C) over end of nipple (E) protruding through mounting bar.
9. Thread other end of nipple (E) with screw collar loop (H) into the crossbar (A) until snug.
10. Take this crossbar (A) assembly and mount to ceiling junction box with the mounting screws (B) (Size: #8-32*0.6"L). The side of the mounting bar marked "GND" must face out.
11. Using proper chain pliers to open one end link of the chain (I) and connect to the loop (J). Close the link (Fig.1).
12. By measuring, determine correct number of links needed for desired hanging height. Using proper chain pliers, disconnect and discard remaining chain.
13. Lace the fixture wires through the chain links. Slip loop collar (G) and canopy (F) over the chain.
14. Open the other end of the chain (I) and connect to loop (H). Close the link.
15. Feed the fixture wires through the loop (H), and nipple (E) and pull until taut.

CONNECTING THE WIRES (Fig.3)

16. At this point, connect the electrical wires as shown in Fig. 3, making sure that all wire connectors are secured. If your outlet box has a ground wire (green or bare copper), connect the fixture's ground wire directly to the mounting plate using the green screw provided. After the wires are connected, tuck them carefully inside the outlet box.

COMPLETING THE INSTALLATIONS (Fig. 1)

17. Raise the canopy (F) all the way to the ceiling. Raise the loop collar (G) and thread onto collar loop (H) protruding through canopy (Fig.1)

Install the light bulb(s) in accordance with the fixture's specification. **DO NOT EXCEED THE MAXIMUM WATTAGE RATING! (NE PAS DEPASSER LA PUISSANCE NOMINALE MAXIMALE!).**

Your installation is now complete. Return power to the junction box and test the fixture.

Note: Illustration (Fig.2) on this manual is for installation purposes only. It may or may not be identical to the fixture purchased.

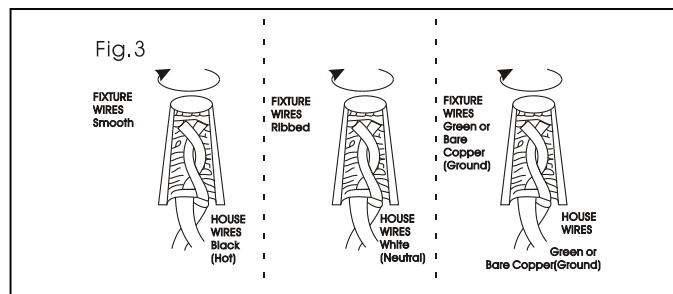
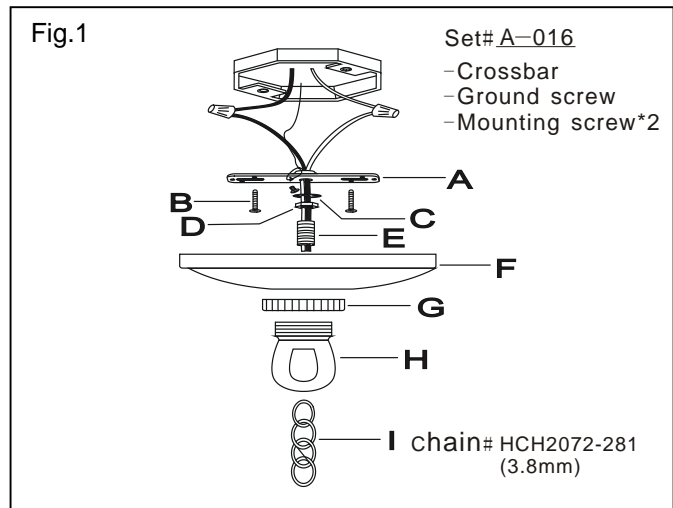
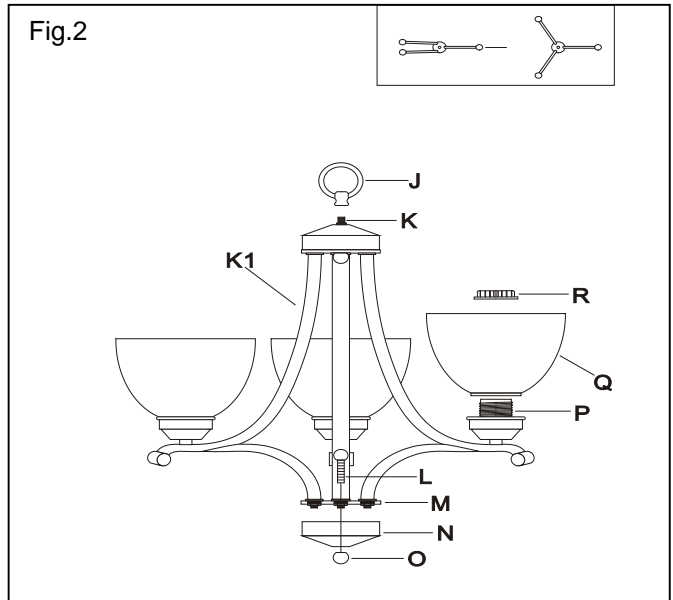

Notice: It is important to use proper chain pliers (not included) To OPEN and CLOSE the chain included with this fixture. Do not open them with other tools that may twist or stress the chain links. It is important to use proper chain pliers like the ones shown in the diagram.