



Ceramic/Impressions®

Vitreous Top and Basin Bathroom Sink

K-2891-1

Features

- Vitreous China
- Integrated top and bowl
- With overflow
- Single faucet hole
- 49" (1245 mm) x 22-3/8" (568 mm)



Codes/Standards







ASME A112.19.2/CSA B45.1

KOHLER® One-Year Limited Warranty

See website for detailed warranty information.

Available Color/Finishes

Color tiles intended for reference only.

Color	Code	Description
	G81	
	G82	
	G83	
	G85	
	G86	
	G88	

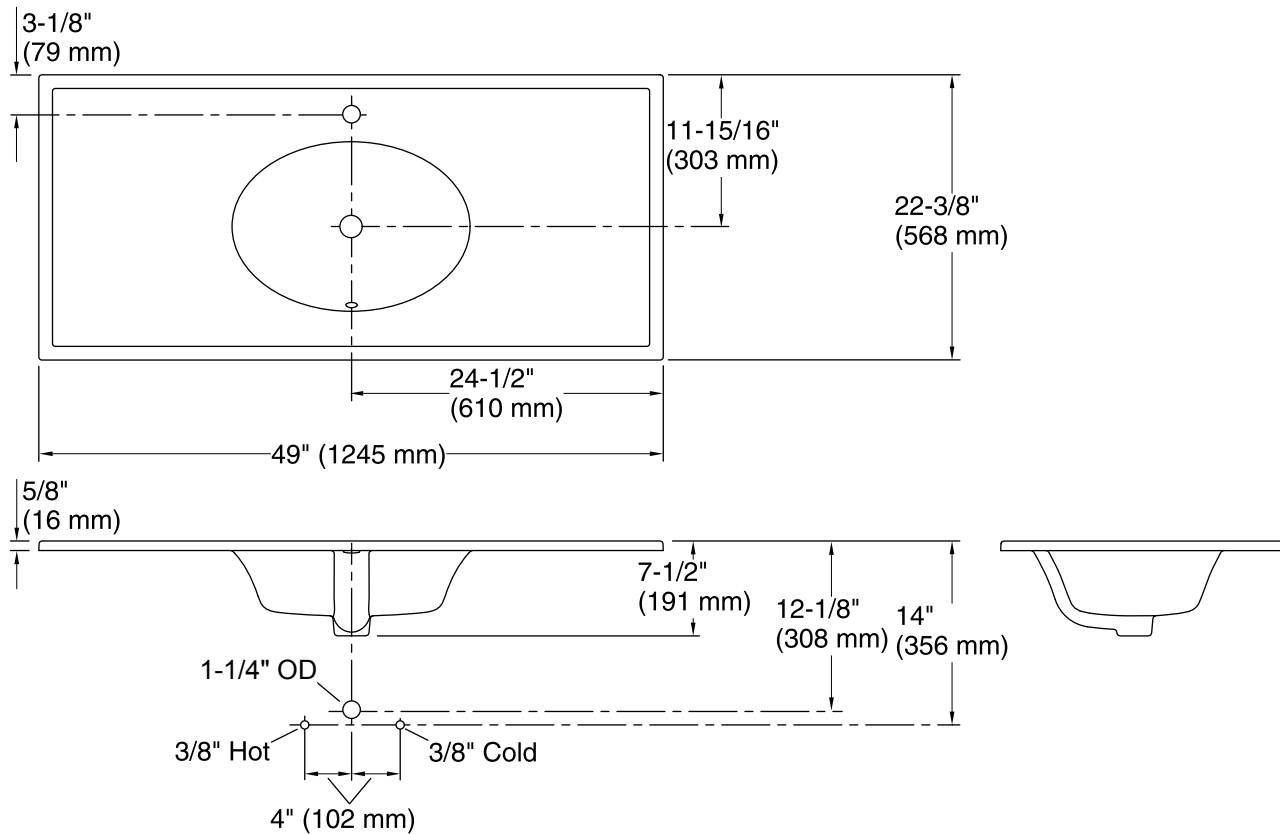

Technical Information

All product dimensions are nominal.

Bowl configuration:	Single
Installation:	Vanity top
Bowl area (Only)	Length: 19" (483 mm) Width: 13-3/8" (340 mm) Bowl depth: 5-1/2" (140 mm) Water depth: 4" (102 mm)
Number of deck holes:	1
Faucet hole(s):	1-3/8" (35 mm)
Drain hole:	1-3/4" (44 mm)

Notes

Install this product according to the installation guide.

This sink is designed to be installed as an integrated vanity top to a KOHLER or standard vanity.