

### Features

- Column lets you customize your shower with a rainhead and handshower.
- Arched shower arm makes it possible to install with low ceiling heights.
- Patent-pending technology allows for an easy bath/shower installation.
- Slidebar bracket allows you to adjust height and angle of handshower.
- Diverter at the base of the column makes for easy toggling between handshower and rainhead.
- Rainhead and handshower sold separately to allow for customized components.
- Developed and optimized for use with KOHLER handshowers and KOHLER Katalyst™ rainheads K-13688, K-13689, K-13692, and K-13695 (sold separately).
- KOHLER finishes resist corrosion and tarnishing.

### Material

- Premium metal construction.

### Installation

- Wall-mount bath or shower installation.
- Installs in less than 60 minutes without changes to in-wall plumbing (subject to condition of existing installation).
- May require additional service parts based on installation type (see installation guide or specification sheet for details).
- Includes an adapter that will fit with most installations but may require one or more kits (sold separately).

### Recommended Products/Accessories

1187917 1/2" NPT Shallow Rough-in Kit  
 1194302 Large Escutcheon/Mounting Collar Kit  
 1194630 1/2" NPT Deep Rough-in Kit  
 K-13688 Contemporary Round Rain Showerhead  
 K-13689 Rain Showerhead  
 K-13692 Traditional Round Rain Showerhead  
 K-13695 Contemporary Square Rain Showerhead

### Components

Additional included component/s: Column, Slidebar, Bracket, and Hose.

Installed component/s: Column, Bracket, Hose, and Slidebar.



ADA CSA B651 OBC

### Codes/Standards







ASME A112.18.1/CSA B125.1  
 ADA  
 ICC/ANSI A117.1  
 CSA B651  
 OBC

### KOHLER® Faucet Lifetime Limited Warranty

See website for detailed warranty information.

### Available Colors/Finishes

*Color tiles intended for reference only.*

Color	Code	Description
	CP	Polished Chrome
	SN	Vibrant® Polished Nickel
	BN	Vibrant® Brushed Nickel
	BV	Vibrant® Brushed Bronze
	2BZ	Oil-Rubbed Bronze
	TT	Titanium

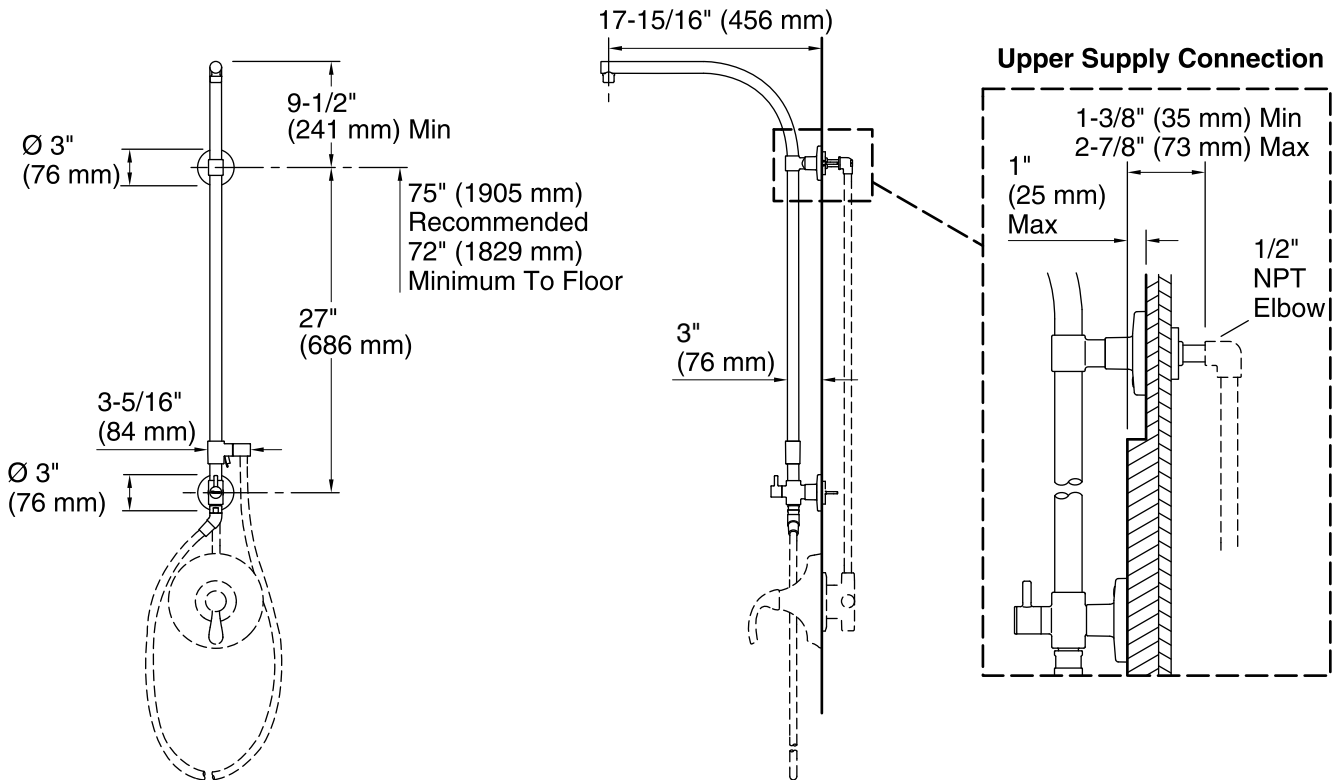

**NOTE:** Valve trim and hose illustrated for dimensioning only, not included in the product.

### Technical Information

All product dimensions are nominal.

### Notes

Install this product according to the installation guide.

Order deep roughing-in kit 1194630 if the distance from the elbow to the finished wall surface is between  $2\text{-}7/8''$  (73 mm) to  $4''$  (102 mm).

Order shallow roughing-in kit 1187917 if the distance from the elbow to the finished wall surface is less than  $1\text{-}3/8''$  (35 mm).

A  $3''$  (76 mm) escutcheon/mounting collar is supplied to fit a  $1''$  (25 mm) to  $1\text{-}1/4''$  (32 mm) supply connection hole diameter. Order 1194302 large escutcheon/mounting collar kit if the supply connection hole diameter is between  $1\text{-}1/4''$  (32 mm) to  $2\text{-}1/4''$  (57 mm).

ADA, OBC, CSA B651 compliant when installed to the specific requirements of these regulations.