



## Whitehaven®

Smart Divide® 35-1/2" undermount double-bowl  
farmhouse kitchen sink with short apron  
**K-6426**

### Features

- 36" minimum base cabinet width
- Large/medium bowls
- 9" (229 mm) depth provides generous workspace
- Shortened apron allows sink to be used in most standard cabinetry or retrofitted to existing standard cabinetry
- Self-Trimming® apron overlaps cabinet face for easy installation and beautiful results
- Smart Divide® feature offers a lower bowl divider that increases workspace versatility
- Bowl slopes toward drain to minimize water pooling
- Offset drain increases workspace in the sink and storage space underneath

### Material

- KOHLER® enameled cast iron

### Installation

- Undermount

### Recommended Products/Accessories

K-5828 Sink Rack  
K-5874 Sink Rack  
K-8801 Sink drain and strainer with tailpiece  
K-8799 Sink drain and strainer basket  
K-23726 Drain treatment  
K-23725 Cast iron cleaner

### Optional Products/Accessories

K-11352 Disposal Flange with Stopper  
K-9000 P-Trap



### Codes/Standards









ASME A112.19.1/CSA B45.2

### KOHLER® Enameled Cast Iron Kitchen and Bathroom Sink Lifetime Limited Warranty

See website for detailed warranty information.

### Available Colors/Finishes

*Color tiles intended for reference only.*

Color	Code	Description
	0	White
	FF	Sea Salt™
	96	Biscuit
	NY	Dune
	95	Ice™ Grey
	58	Thunder™ Grey
	7	Black Black™
	TRF	Truffle
	PLM	Black Plum

1-800-4KOHLER (1-800-456-4537)

Kohler Co. reserves the right to make revisions without notice to product specifications.

For the most current Specification Sheet, go to [www.kohler.com](http://www.kohler.com).

10-22-2023 20:50 - US/CA/MX

THE BOLD LOOK  
OF **KOHLER**®

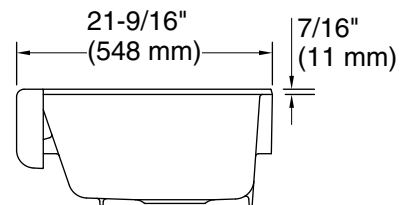
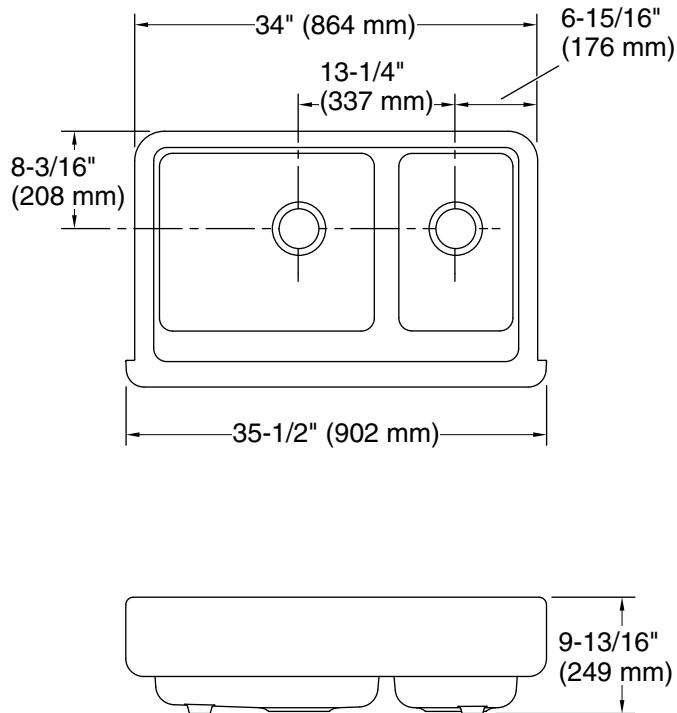

### Technical Information

All product dimensions are nominal.

Bowl configuration: Off-set Large/small

Min. base cabinet width: 36" (914 mm)

Bowl area: Length: 18-13/16" (478 mm)  
Width: 18-1/16" (459 mm)  
Bowl depth: 9" (229 mm)

Bowl area: Length: 10-5/16" (262 mm)  
Width: 18-1/16" (459 mm)  
Bowl depth: 9" (229 mm)  
Water depth: 9" (229 mm)

Drain hole: 3-5/8" (92 mm)

### Notes

Install this product according to the installation instructions.

**NOTICE:** The countertop manufacturer or cutter must use the cut-out template provided with the product, or a current one provided by Kohler Co. (call 1-800-4KOHLER). Kohler Co. is not responsible for cut-out errors when the incorrect cut-out template is used.

**IMPORTANT!** The distance from the top edge of the cabinet to the top of the cabinet door must be at least 6-7/8" (175 mm) to install this sink.