

Features

- 30-inch minimum base cabinet width.
- Single bowl.
- 9-inch depth.
- Five oversized faucet holes.
- Bowl slopes 2 degrees toward drain to minimize water pooling.
- Offset drain increases workspace in the sink and storage space underneath.
- Includes K-6239 colander with integral cutting board and K-9137 bottom sink rack.

Material

- KOHLER® enameled cast iron.

Installation

- Under-mount

Recommended Products/Accessories

K-9000 P-Trap
K-6377 Sponge Caddy
K-6378 Kitchen Brush Caddy
K-6379 Kitchen Squeegee
K-6382 Disinfecting Wipes Dispenser
K-6383 Soap Dispenser
K-8618 Paper Towel Holder
K-8619 Flexible Kitchen Mat
K-8624 Dish Scraper
K-8801 Sink Strainer
K-8799 Sink Strainer

Included Components

Product consists of:
K-9137 Sink Rack
K-6239 Colander with Cutting Board



Codes/Standards

















ASME A112.19.1/CSA B45.2

KOHLER® Enameled Cast Iron Kitchen Sink Lifetime Limited Warranty

See website for detailed warranty information.

Available Colors/Finishes

Color tiles intended for reference only.

Color	Code	Description
	0	White
	FF	Sea Salt™
	96	Biscuit
	47	Almond
	FD	Cane Sugar™
	NY	Dune
	95	Ice™ Grey
	G9	Sandbar
	33	Mexican Sand™
	K4	Cashmere
	FT	Basalt
	58	Thunder™ Grey
	20	Suede
	KA	Black 'n Tan
	FP	Caviar
	7	Black Black™

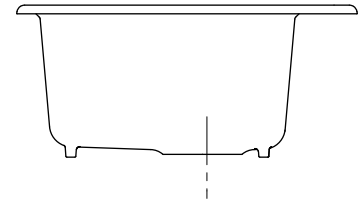
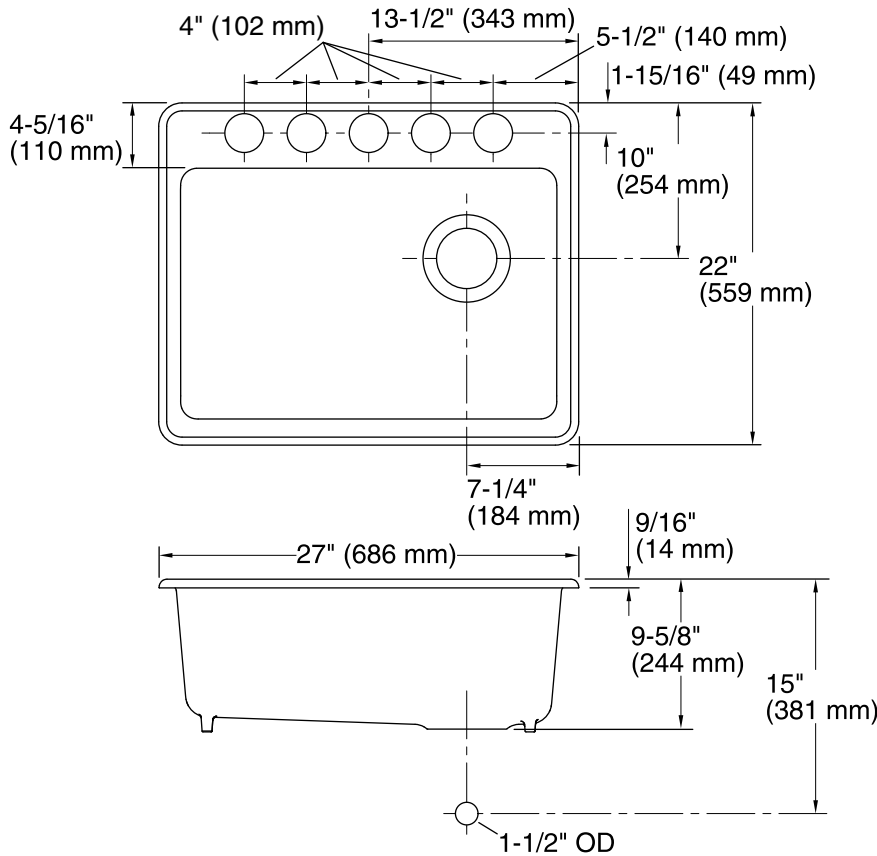

Technical Information

All product dimensions are nominal.

Installation: Under-mount

Min. base cabinet width: 30" (762 mm)

Bowl area: Length: 24-1/4" (616 mm)
Width: 17-1/4" (438 mm)
Bowl depth: 9" (229 mm)
Water depth: 9" (229 mm)

Number of deck holes: 5

Template: 1244382-7, required, included

Notes

Install this product according to the installation instructions.