

AIRE DELUXE™

FP6285B**
52" Ceiling Fan

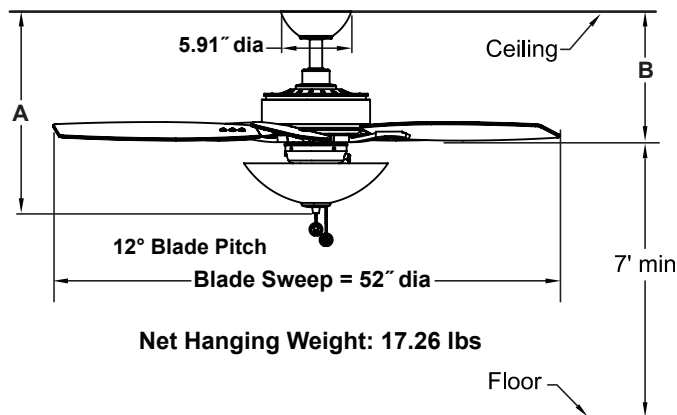
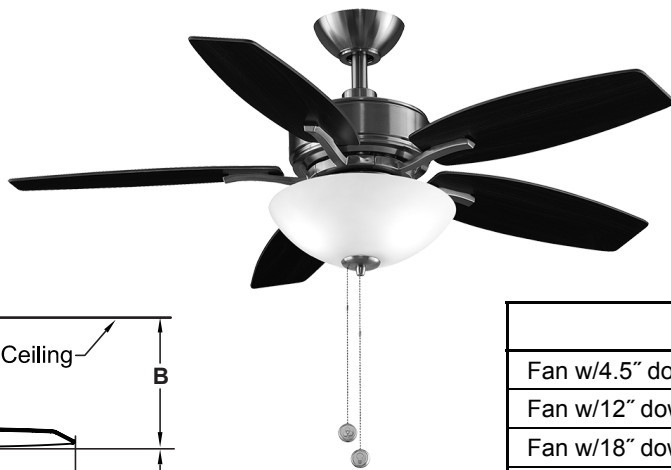

| | A | B |
|--------------------|--------|--------|
| Fan w/4.5" downrod | 17.36" | 10.59" |
| Fan w/12" downrod | 24.86" | 18.09" |
| Fan w/18" downrod | 30.86" | 24.09" |
| Fan w/24" downrod | 36.86" | 30.09" |
| Fan w/36" downrod | 48.86" | 42.09" |
| Fan w/48" downrod | 60.86" | 54.09" |
| Fan w/60" downrod | 72.86" | 66.09" |
| Fan w/72" downrod | 84.86" | 78.09" |

INSTALLATION REQUIREMENTS:

Ceiling fan attaches to electrical junction box securely anchored and capable of withstanding a load of at least 35 lbs.

ELECTRICAL REQUIREMENTS:

Ceiling fan requires a grounded electrical supply line of 120 volts AC, 60 Hz, 15 amp circuit.

MOTOR SPECS:

153 x 15 AC motor is designed for optimal performance with this fan.

BLADE SETS:

A set of five 21" reversible plywood blades is included.

CONTROL OPTIONS:

Three fan speeds pull chain control included. The reverse switch is located on the switch housing. Optional CW1SW, CW2, CWRL4 and CW60WH wall controls, BTCR9, C4, CRL4WH and CRL8TS remote controls with receiver unit and BTR9 receiver unit are available—sold separately. Instructions are provided with each control.

LIGHTING OPTIONS:

Two E26 9-watt LED bulbs included.

DOWNROD OPTIONS:

Fan comes with 1" dia. x 4.5" long downrod. Optional downrods available in 12", 18", 24", 36", 48", 60", and 72" lengths. A downrod coupler is available for installations requiring a downrod longer than 72". Fan can be mounted on a sloped ceiling upto 19°. Most sloped ceiling installations require a downrod longer than the standard 4.5" downrod. Optional close-to-ceiling kit is available as well—sold separately. Optional sloped ceiling kits (SCK1-52) are available for up to 42°. Call technical support for more information.

LOCATION USE:

Fan is rated for dry locations only.

| Available Finish | |
|------------------|--|
| BN | Brushed Nickel With Cherry/Dark Walnut Blade and Frosted White Glass |
| DZ | Dark Bronze With Cherry/Dark Walnut Blade and Frosted White Glass |
| GR | Matte Greige With Weathered Wood Blade and Frosted White Glass |
| MW | Matte White With Matte White Blade and Frosted White Glass |

| Airflow / Energy Efficiency Info (120V) | | | | | |
|---|---------|------|-------------|------|-------|
| Fan Speed | Max RPM | CFM | CFM / Watts | Amps | Watts |
| High | 158 | 4842 | 88 | 0.46 | 55 |
| Med | 113 | 3222 | 124 | 0.33 | 26 |
| Low | 67 | 1927 | 186 | 0.20 | 10 |

| Energy Guide FTC | | | |
|---------------------------|--|-----------------------------------|--------------------------------|
| Power (W _{ave}) | Total Air Delivery (CFM _{ave}) | Estimated Yearly Energy Cost (\$) | Ceiling Fan Efficiency (CFM/W) |
| 34 | 3476 | 10 | 102 |

| Light Bulb Information (120V) | | | | | |
|-------------------------------|-------|-----|---------------|------------|-----|
| Bulb Type | Watts | QTY | Lumens Amount | Color Temp | CRI |
| E26 / LED | 9 | 2 | 1620 | 2700 | 90% |