

WARNING: DISCONNECT POWER AT THE MAIN FUSE BOX BEFORE INSTALLATION.

WARNING:

This fixture is intended for installation in accordance with the National Electrical Code (NEC) and all local code specifications. If you are not familiar with code requirements, installation by a certified electrician is recommended.

Before assembly, remove all parts and part packages from box. If anything is missing, please contact the retailer from which the product was purchased.

elk HOME

ANY QUESTIONS CALL: 800-613-3261
M-F 8:00AM-6:00PM ET

ITEM#: 63106/1

1. Carefully pull house wires down out of junction box so house wires are easily accessed to connect fixture wires.
2. If screw collar loop (W) is already attached to mounting bracket (A), proceed to Step 3. To assemble screw collar loop (W) to mounting bracket (A): Hold mounting bracket (A) so head of ground screw is pointing down towards floor. Hold threaded pipe so two hexnuts already attached to threaded pipe (E) are pointing down towards floor. From side of mounting bracket with ground screw head, screw short end of threaded pipe (E) into hole in center of mounting bracket (A) until hexnut on threaded pipe (E) touches mounting bracket. Thread hexnut (V) onto end of threaded pipe (E). Tighten hexnut (V) to secure threaded pipe (E) to mounting bracket (A). Thread screw collar loop (W) onto end of threaded pipe pointing down towards floor. Tighten screw collar loop up against hexnut on threaded pipe (E).
3. Place mounting bracket (A) up against junction box. Screw collar loop (E) should be pointing down towards floor. Align each slot in mounting bracket (A) with each hole in junction box.
4. Thread one junction box screw (B) into each slot in mounting bracket (A) and into holes in junction box. Tighten junction box screws (B) to secure mounting bracket (A) to junction box.

CAUTION: Make sure house wires are still easily accessible. **DO NOT** pinch wires between mounting bracket and ceiling.

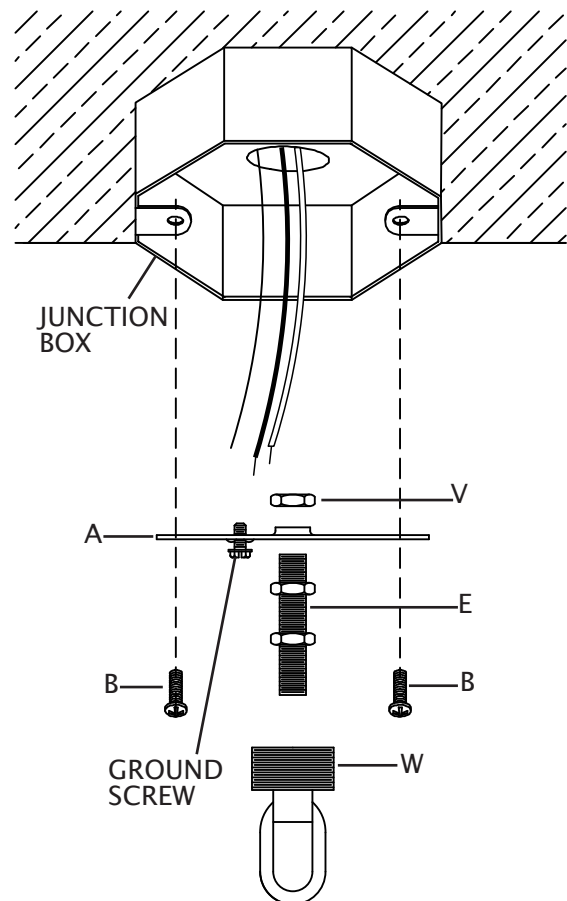

5. Screw bulb (G16 bulb required, not included) into socket. Verify correct bulb wattage marked on socket of fixture. **WARNING: DO NOT** exceed maximum bulb wattage.
 6. Fit glass shade (K) inside outer shade (O). Carefully pass hole in top of glass shade (K) over bulb. Fit ring on top of glass shade (K) over plate on top of socket. Carefully turn glass shade (K) clockwise to secure glass shade (K) in place.
- CAUTION:** At least one 6 inch stem must be used.
7. Carefully push fixture wires up through bottom of 6 inch stem (N). Pull fixture wires out of top of 6 inch stem (N). Screw bottom of 6 inch stem (N) onto top of fixture body.
 8. Determine desired hanging height of fixture. Select the quantity of stems (M) to achieve that height.
 9. Carefully push fixture wires up through end of one 12 inch stem (M). Thread end of stem (M) onto top of stem (N).
 10. Carefully push fixture wires through remaining stems (M). Screw stems (M) together keeping fixture wires taut. **DO NOT** pinch fixture wires between stems.
 11. Push fixture wires up through bottom of loop (S). Thread loop onto top of last stem (M).
 12. Slip threaded ring (F) down over fixture wires.
 13. Position canopy (D) so outside of canopy is pointing down towards fixture. Slip hole in canopy (D) over end of fixture wires.

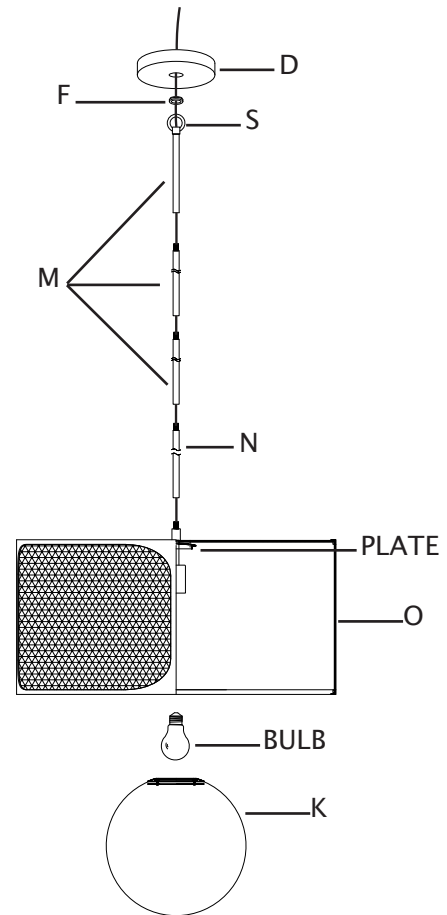

14. Strip 3/4" of insulation from ends of fixture wires.
15. Carefully push fixture wires up through hole in screw collar loop (W) attached to mounting bracket (A) and out end of threaded pipe inside junction box. Carefully pull fixture wires so they are easily accessible to connect to house wires.
16. Slightly loosen ground screw on mounting bracket (A). Do not completely remove ground screw. Wrap house ground wire (copper) around ground screw, leaving enough ground wire to attach to fixture ground wire. Twist end of fixture ground wire and end of house ground wire together. Twist wire nut (C) onto ends of wires. Completely tighten wire nut (C). Reference chart below for correct wire connections.

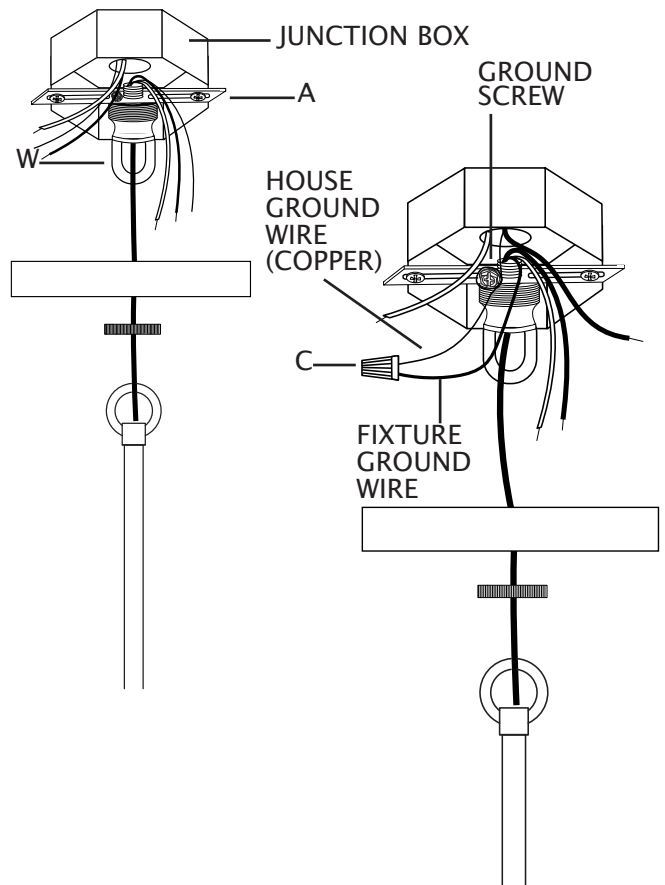

Connect Supply (House) Ground Copper Wire to:
Bare Copper Wire or,
Bare Silver Wire or,
Green Insulated Wire.

17. Twist end of house lead wire (black) and end of fixture lead wire together. Twist wire nut (C) onto ends of wires. Completely tighten wire nut (C). Twist end of house neutral wire (white) and end of fixture neutral wire together. Twist wire nut (C) onto ends of wires. Completely tighten wire nut (C). Reference chart to the right for correct wire connections.
18. Wrap electrical tape (not included) around wire nuts (C) and wires. Ensure wires are securely fastened into wire nuts.
19. Carefully push all wires and wire nuts into junction box.

Connect Black Lead Supply (House) Wire to:	Connect White Neutral Supply (House) Wire to:
Black Wire or,	White Wire or,
*Parallel Cord (Round and Smooth) or,	*Parallel Cord (Square and Ridged) or,
No printed words on wire insulation or,	Printed words on wire insulation or,
Insulated Wire (other than green) with Copper Conductor.	Insulated Wire (other than green) with Silver Conductor.
*When parallel wire (SPT 1 & SPT 2) is used: The lead wire is round in shape or smooth. The neutral wire is square in shape or ridged.	

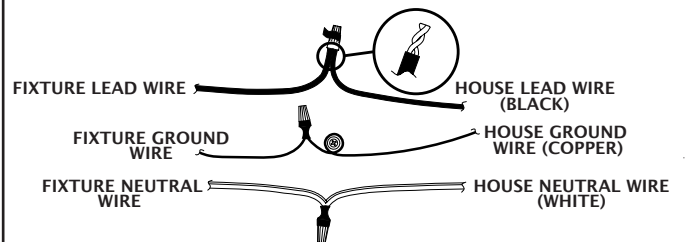

20. Raise canopy (D) up to ceiling. Pass hole in canopy (D) over screw collar loop (W). Position canopy (D) up against ceiling.
21. Raise threaded ring (F) up to canopy (D). Screw threaded ring (F) onto screw collar loop (W). Tighten threaded ring (F) to secure fixture to ceiling.
22. Attach locking link (G) to loop (S) on top of stem and to screw collar loop (W).

