

**PRODUCT SPECIFICATIONS**

Elkay Lustertone™ Classic Stainless Steel 25" x 21-1/4" x 5-1/2", Single Bowl Drop-in ADA Sink. Sink is manufactured from 18 gauge 304 Stainless Steel with a Lustrous Satin finish, Rear Center drain placement, and Bottom only pads.

<b>Installation Type:</b>	Drop-in
<b>Material:</b>	304 Stainless Steel
<b>Special Features:</b>	Quick-Clip Mounting System
<b>Finish:</b>	Lustrous Satin
<b>Gauge:</b>	18
<b>Sound Deadening:</b>	Bottom only pads
<b>Number of Bowls:</b>	1
<b>Sink Dimensions:</b>	25" x 21-1/4" x 5-1/2"
<b>Bowl 1 Dimensions:</b>	21" x 15-3/4" x 5-3/8"
<b>Drain Size:</b>	3-1/2" (89mm)
<b>Drain Location:</b>	Rear Center
<b>Minimum Cabinet Size:</b>	30"
<b>Mounting Hardware:</b>	Included for 3/4" (19mm) countertop
<b>Cutout Template #:</b>	<a href="#">1000001245</a>

Template is available for download at [elkay.com](#)

**Cutout Dimensions for Top Mount Installation:**

24-3/8" x 20-5/8" (619mm x 524mm) with 1-1/2" (38mm) corner radius

**Hole Drilling Configurations:**

1-1/2" (38mm) Diameter Faucet Holes on 4" (102mm) Centers

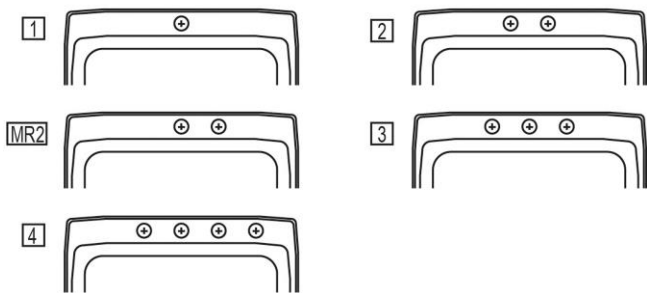

**Installation Profile:**

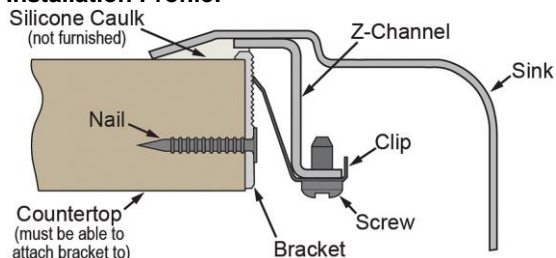

**AMERICAN PRIDE. A LIFETIME TRADITION.**

Like your family, the Elkay family has values and traditions that endure. For almost a century, Elkay has been a family-owned and operated company, providing thousands of jobs that support our families and communities.



**Product Compliance:** ADA & ICC A117.1  
ASME A112.19.3/CSA B45.4  
BUY AMERICAN ACT



Sinks are listed by IAPMO® as meeting the applicable requirements of the Uniform Plumbing Code®, International Plumbing Code®, and National Plumbing Code of Canada.



Complies with ADA & ICC A117.1 accessibility requirements when installed according to the requirements outlined in these standards.

- [Clean and Care Manual \(PDF\)](#)
- [Installation Instructions \(PDF\)](#)
- [Limited Lifetime Warranty \(PDF\)](#)

**Similar models are available with:** additional ADA depths, U Channel mounting system

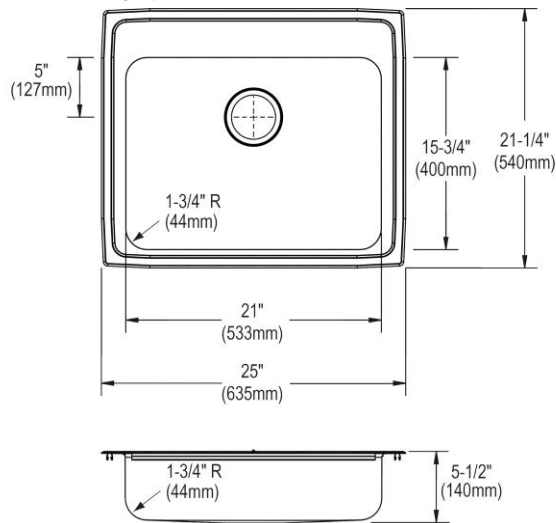

PART: \_\_\_\_\_ QTY: \_\_\_\_\_

PROJECT: \_\_\_\_\_

CONTACT: \_\_\_\_\_

DATE: \_\_\_\_\_

NOTES: \_\_\_\_\_

APPROVAL: \_\_\_\_\_

*In keeping with our policy of continuing product improvement, Elkay reserves the right to change product specifications without notice. Please visit [elkay.com](#) for the most current version of Elkay product specification sheets. This specification describes an Elkay product with design, quality, and functional benefits to the user. When making a comparison of other producers' offerings, be certain these features are not overlooked.*

**OPTIONAL ACCESSORIES**

<b>Bottom Grid:</b>	LKWOBG2115SS
<b>Cutting Board:</b>	CB1516
<b>Drain:</b>	LK99, LKAD35
<b>Faucet:</b>	LKGT1041, LKGT2041
<b>Rinsing Basket:</b>	LKWERBSS
<b>Soap Dispenser:</b>	LKGT1054

*In keeping with our policy of continuing product improvement, Elkay reserves the right to change product specifications without notice. Please visit [elkay.com](http://elkay.com) for the most current version of Elkay product specification sheets. This specification describes an Elkay product with design, quality, and functional benefits to the user. When making a comparison of other producers' offerings, be certain these features are not overlooked.*